

cor light ...

# LS33Q satiné ... modular

## Street lighting unit

Optimized for the S-classes of street lighting in accordance with EN 13201

- Typical ratio of 5.5 for pole distance to mounting height



- Numerous options for attaching and configuring
- Power rating up to 600 mA, dimmable
- Highest system efficiency
- Sustainable and future-oriented
- Multichip technology
- ESD-protection
- CRI 70 min

### Unit structure

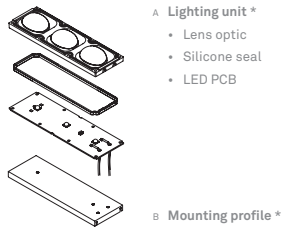

\* Specific article number

### A Lens optic

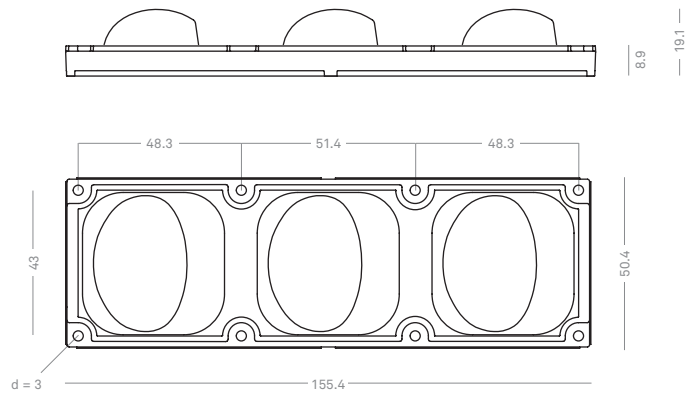

### Light distribution

#### Polar diagram

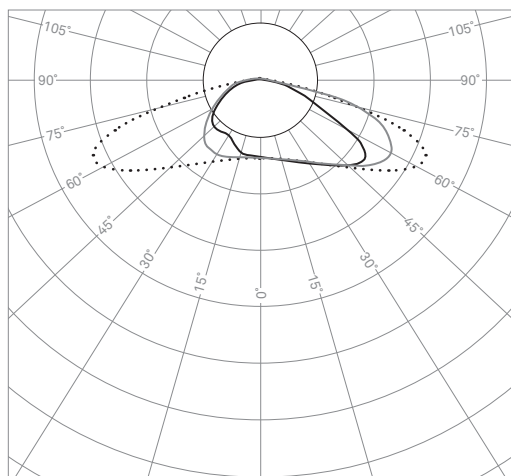

... C0-C180 — C30-C210 - - C90-C270

#### Illuminance distribution

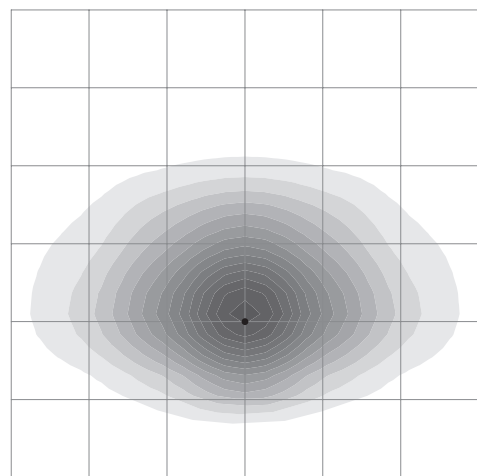

● — ● Mounting height

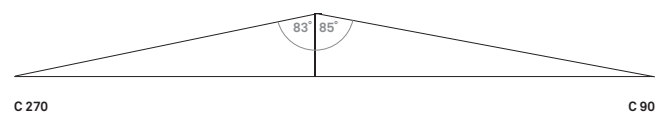
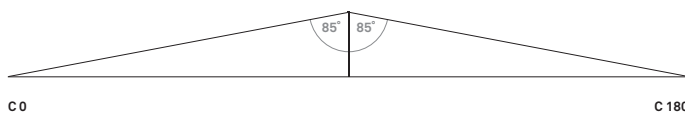

**Variants**

V<sub>F</sub> 35 V

→ Article no. **see table below + variant**

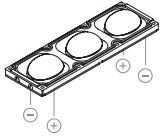

Variant **04** (power outlet underneath): IP67 rating in combination with mounting profile

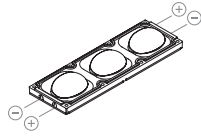

Variant **03** (power outlet on side): IP67 rating

Article no.	Colour temperature (K) (typical)	No. of LED	Power (W)				Lumen (lm) (25°C ambient temperature including optical system loss)				Luminous efficacy of LED module (lm/W); (25°C ambient temperature including optical system loss)				Life time (h)
			300 mA	400 mA	500 mA	600 mA	300 mA	400 mA	500 mA	600 mA	300 mA	400 mA	500 mA	600 mA	
1 16 0001 ___	3000	3	9,9	13,2	16,5	19,8	1307	1659	1978	2266	132,1	125,5	119,6	114,2	50000
1 16 0002 ___	4000	3	9,9	13,2	16,5	19,8	1397	1777	2116	2427	141,1	134,4	128,0	122,3	50000
1 16 0003 ___	5700	3	9,9	13,2	16,5	19,8	1397	1777	2116	2427	141,1	134,4	128,0	122,3	50000

→ Article no. **example**  
Lighting unit with power outlet underneath: **1 16 0001 04**

Note: the product code is complete only if the variant is indicated.

Prerequisite for compliance of the data sheet specifications is the observation of temperature limits  
T<sub>c</sub> < 80°C @ 600mA and 25°C ambient temperature  
Temperature measuring unit available

**B Mounting profile** (optional)

- Can be used for lighting units variant 03 and 04

Recommended mounting screws included: BN 20165 – M 2.5 × 12 mm

**3 mounting profile**

→ Article no. **40 2000 010**

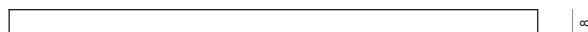
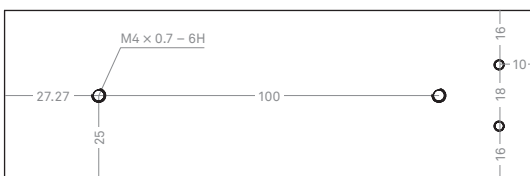
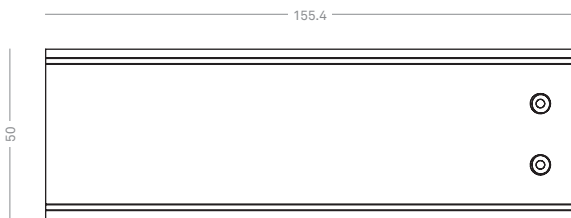
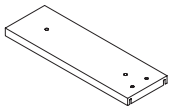

Assembly and maintenance instruction on [www.corlight.com](http://www.corlight.com)