

cor light ...

LS33 modular



Street lighting unit

Optimized for the S-classes of street lighting in accordance with EN 13201

- Typical ratio of 5.5 for pole distance to mounting height

- Numerous options for attaching and configuring
- Power rating up to 600 mA, dimmable
- Highest system efficiency
- Sustainable and future-oriented
- Multichip technology
- ESD-protection
- CRI 70 min

Unit structure

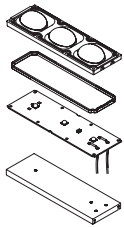

- A Lighting unit ***
- Lens optic
 - Silicone seal
 - LED PCB

- B Mounting profile ***

* Specific article number

A Lens optic

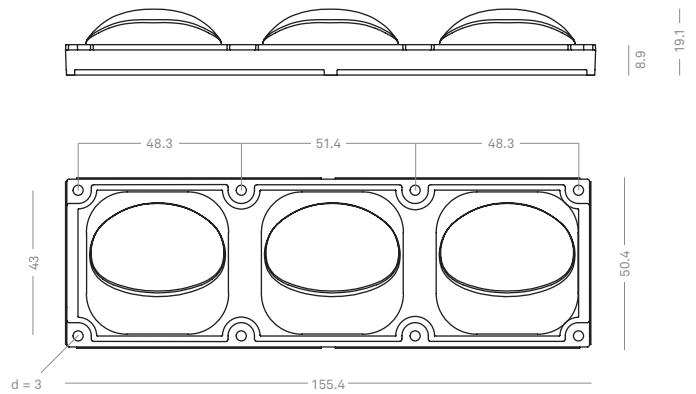

Light distribution

Polar diagram

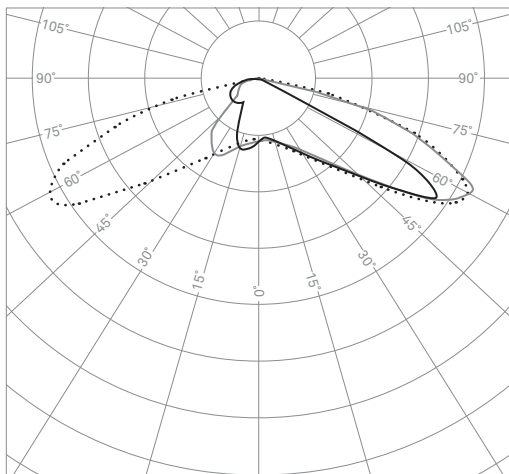

... C0-C180

— C30-C210

— C90-C270

●—● Mounting height

Illuminance distribution

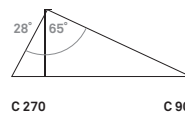
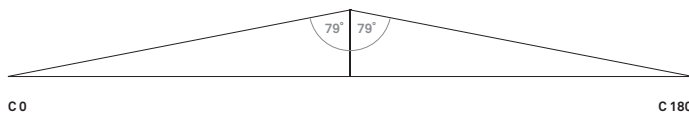
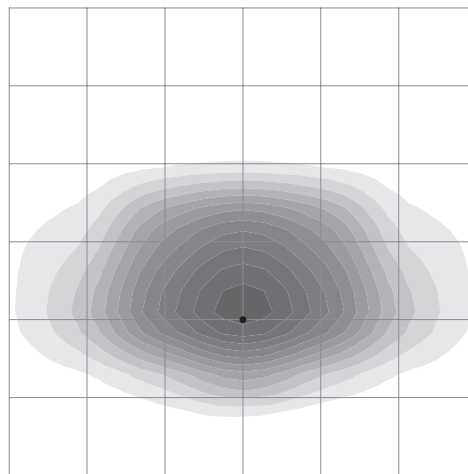

C0

C180

C270

C90

Variants

V_F 35 V

→ Article no. **see table below + variant**

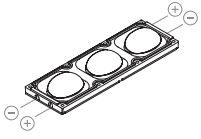

Variant **01** (power outlet on side): IP67 rating

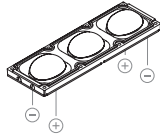

Variant **02** (power outlet underneath): IP67 rating in combination with mounting profile

Article no.	Colour temperature (K) (typical)	No. of LED	Power (W)				Lumen (lm) (25°C ambient temperature including optical system loss)				Luminous efficacy of LED module (lm/W); (25°C ambient temperature including optical system loss)				Life time (h)
			300 mA	400 mA	500 mA	600 mA	300 mA	400 mA	500 mA	600 mA	300 mA	400 mA	500 mA	600 mA	
1 07 0001 ___	3000	3	9,9	13,2	16,5	19,8	1390	1764	2103	2409	140,4	133,4	127,2	121,4	50000
1 07 0002 ___	4000	3	9,9	13,2	16,5	19,8	1485	1889	2250	2581	150,0	142,9	136,1	130,1	50000
1 07 0003 ___	5700	3	9,9	13,2	16,5	19,8	1485	1889	2250	2581	150,0	142,9	136,1	130,1	50000

→ Article no. **example**
Lighting unit with power outlet underneath: **1 07 0001 02**

Note: the product code is complete only if the variant is indicated.

Prerequisite for compliance of the data sheet specifications is the observation of temperature limits
T_c < 80°C @ 600mA and 25°C ambient temperature
Temperature measuring unit available

B Mounting profile (optional)

- Can be used for lighting units variant 01 and 02

3 mounting profile

→ Article no. **40 2000 010**

Recommended mounting screws included: BN 20165 – M 2.5 × 12 mm

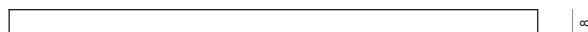
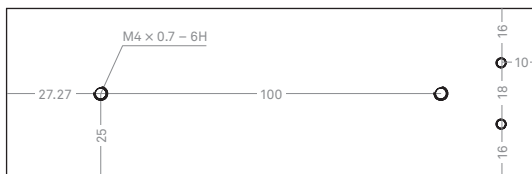
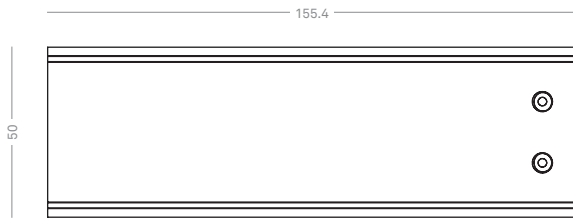
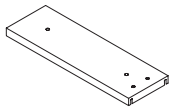

Assembly and maintenance instruction on www.corlight.com